

Varenummer: 0108041
 Beskrivelse: Seeger låsering JK 24 DIN 984

Mål

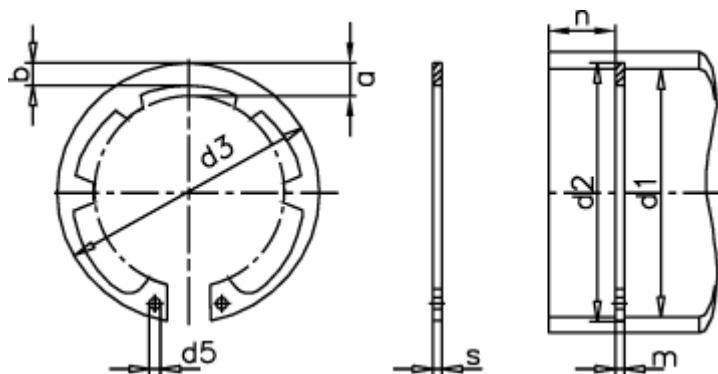

a max	= 4.2	d5 min	= 2.0	s	= 1.20
AN mm ²	= 46.3	FN kN	= 7.7	t	= 0.60
Antal takker	= 6	FRg kN	= 4.6	Tang	= ZGJ-2
b	= 2.6	FR kN	= 13.9	tol	= -0.06
Betegnelse	= JK 24	g	= 1.0	tol	= +0,42-0,21
d1	= 24	K kN-mm	= 28.4	tol	= +0,21
d2	= 25.2	m min	= 1.30	vægt kg/1000	= 1.60
d3	= 26.9	Nominal træk	= 1.8		